



Advanced Drilling Equipment Cutting Tools

January 2015

Precision

- Good surface finish
- Fit to application special cutter with tight hole tolerance

Productivity

- One shot application cutters
- Cutters for high speed applications

Durability

- Special coatings to increase cutter lifetime
- Customized cutter design to reduce run-out

Total Cost of Ownership

- Increased holes per cutter
- More regrinds per cutter options

Advanced Drilling Equipment (ADE/ADU) Cutting Tools



- Standard and special cutters
 - One shot drilling
 - One shot reaming
 - Drill and ream
 - Drill and countersink
 - Square drills (deep hole)
 - Ream and countersink
 - Taperlock ream and countersink

Advanced Drilling Equipment (ADE/ADU) Cutting Tools



Aerospace standard and special cutter definitions

- Standard cutter
 - Cutter that is readily available and stocked by multiple vendors.
 - Generic and basic geometries to cover multiple situations.
- Special cutter
 - Generally not in stock - must be manufactured.
 - Tighter geometry tolerances than a standard cutter
 - Unique geometry features making them application specific.

Advanced Drilling Equipment (ADE/ADU) Cutting Tools are Special Cutters

Why Advanced Drilling Equipment (ADE/ADU) needs Special Cutters

Advantages/disadvantages of ADE/ADU equipment

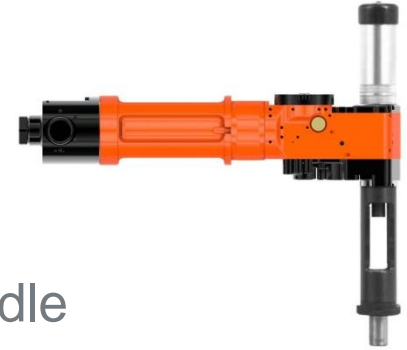

■ Advantages

- Portable
- Lightweight
- Accurate
- Ability to fix RPM and feed rate

■ Disadvantages

- Free floating spindle
- Cutter generally guides in bushing
- Guide can also be on the spindle but runout is still greater than a 'rigid' spindle machine

- *Free floating spindle equals run out*
- *Run out is the cutter's worst enemy*
- *Everything from point of contact with the spindle beyond is designed to mitigate run out*

One shot drilling in Aluminium

- Operation / One shot Drilling
 - Material: Aluminium
 - Thickness: 15 mm / 0.59"
 - Hole diameter: 6.32 mm / 0.250"
 - ADE
 - ADE : 20932
 - Speed: 2700 rpm
 - Feed: 0.07 mm/rev / .003ipr
 - No lubrication (Dry process)
- Solution
 - Non coated drill carbide cutter
- Results
 - Ra [1.4 – 2.5] μm / ~63 μin



- Operation / One shot drilling countersink
 - Material: CF - AL
 - Thickness: 20 mm – 20 mm / 0.787” – 0.787”
 - Hole diameter: 6.357 mm / 0.2500”
 - ADE
 - ADE : 20942M with vibratory system
 - Speed: 4500 rpm
 - Feed: 0.07 mm/rev / .003ipr
 - with lubrication
- Solution
 - Non coated carbide drill & countersink cutter
- Results
 - Cpk CF-Al > 1.6
 - IT9 [32µm]
 - Ra CF = 4.8 µm / ~ 125 µin
 - Ra Al = 0.03 µm / ~ 2 µin

One shot drilling and countersinking in CF-AL



One shot drilling and countersinking

- Operation / One shot Drilling countersink
 - Material: CF - AL
 - Thickness: 9.6 mm – 4.5 mm / .38” - .18”
 - Hole diameter: 6.807 mm / .2680”
 - ADE
 - ADE : 20942M with vibratory system
 - Speed: 4500 rpm
 - Feed: 0.07 mm/ rev / .003ipr
 - with lubrication
- Solution
 - Coated drill & countersink cutter
- Results
 - Cpk CF-Al > 3
 - IT10 [76µm]



- Operation / Reaming
 - Material: Ti-CF- AL
 - Thickness: 7 mm – 19 mm – 12 mm
.28” - .75” - .47”
 - Operation: Reaming
 - Hole diameter: 6.807 mm / .2680”
 - ADE
 - ADE : 20942M with vibratory system
 - Speed: 400 rpm
 - Feed: 0.1 mm/ rev / .004ipr
 - with lubrication
- Solution
 - Non coated square hss reamer
- Results
 - Cpk Ti-CF-Al > 1,6
 - IT9 [32µm]
 - Ra Ti = 0.4µm / ~ 16µin
 - Ra CF = 3.6µm / ~ 125µin
 - Ra AL = 0.12µm / ~ 4µin

Reaming



General cutter terminology

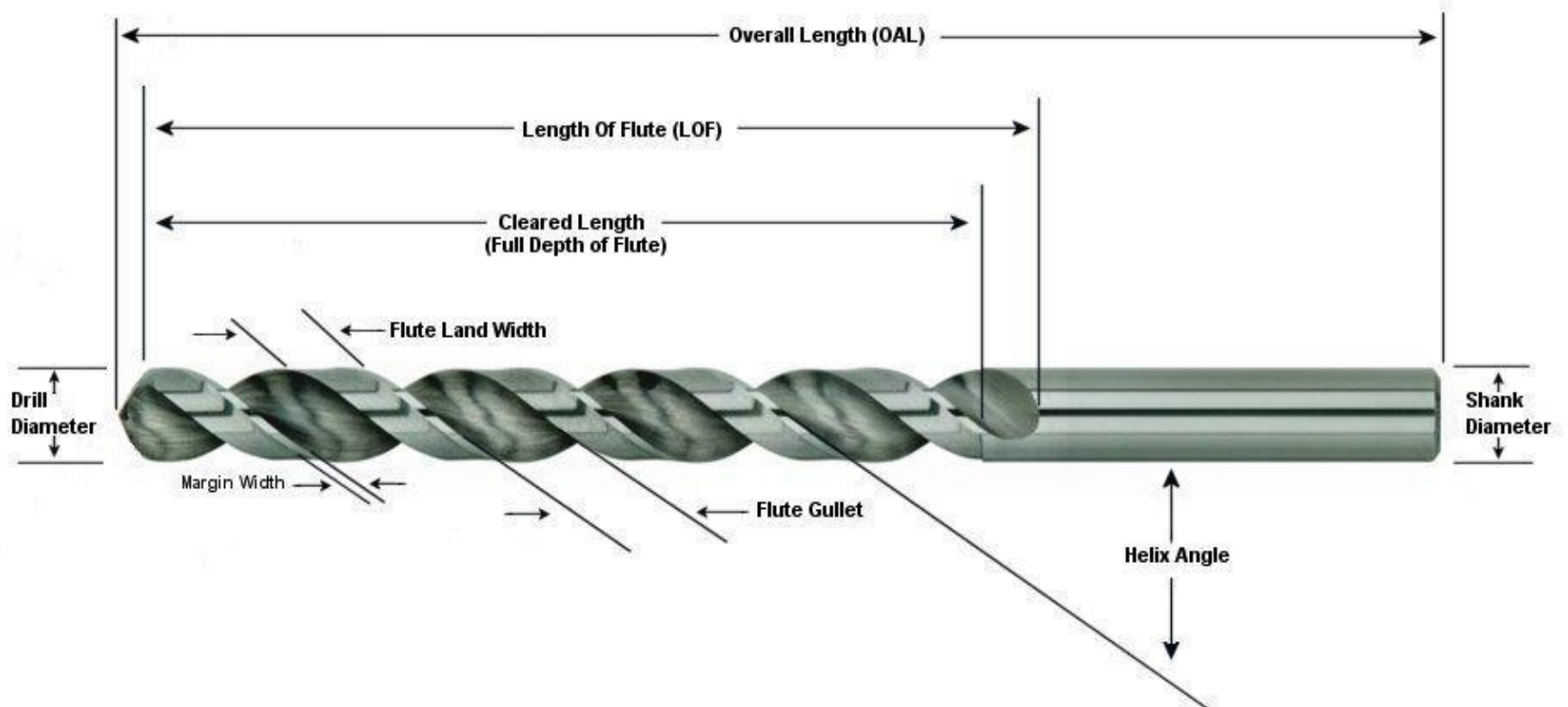

Body



Single Margin



Double Margin

- Standard cutter
 - Generally do not have unique attachment features
 - Shank Diameter (SD) tolerance +0 / - .0005” +0/-.013mm or greater
- Special cutter
 - Double margin configuration (critical for proper support within nose bushing)
 - Back taper .0001 - .0003” / .003 - .008mm entire drill length (critical for proper clearance and support in nose bushing)

Shank

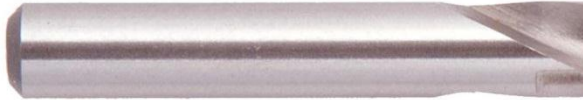

■ Standard

- Generally do not have unique attachment features
- Shank Diameter (SD) tolerance +0 / - .0005”
+0/- .013mm or greater



■ Special

- Threaded shank common often with seat angle or seat shank diameter
- SD tolerance +0 / - .0003”
+0/- .008 mm or less
(critical for **proper** clearance in nose bushing)

Point Geometry

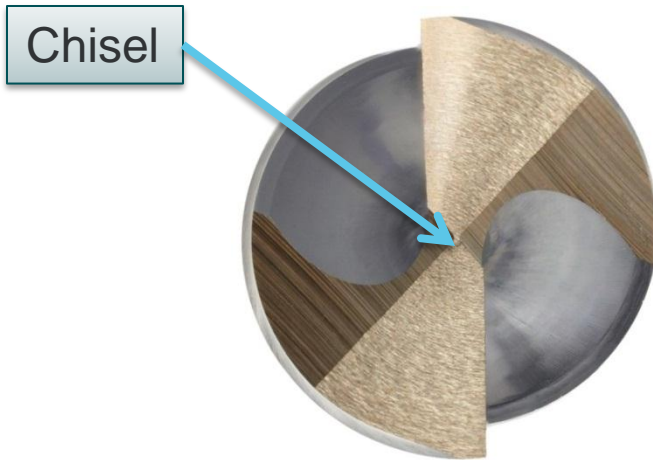

Cutting lip

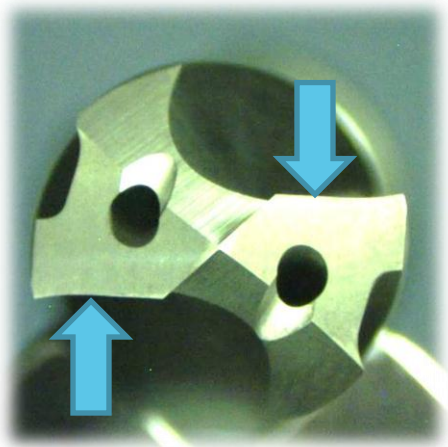

- Two main point geometries that are critical for mitigating spindle run out are:
 - Chisel Centrality
 - Lip-to-lip run out
- The chisel is the first part of the drill to come in contact with the material. If it's not correct, the effects will resonate and cannot be overcome by other geometries

Chisel run out (Centrality)

- Standard Cutter .007" / .18mm or greater
- Special Cutter .0002" / .005mm or less

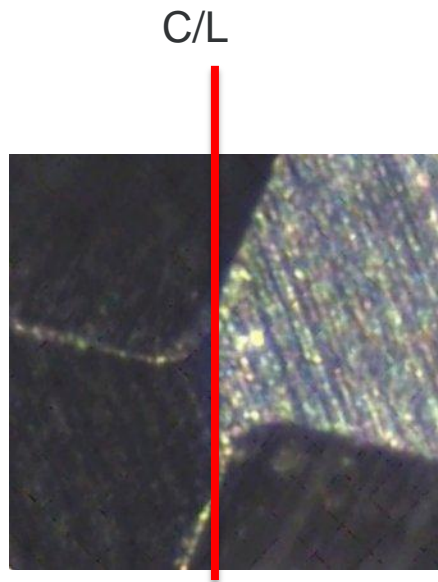

- Line up chisel in center line (C/L)

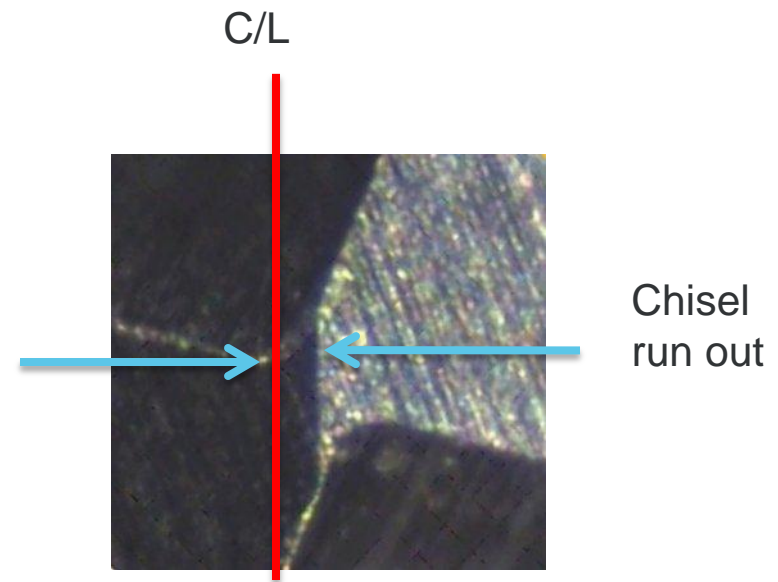

- Rotate tool 180°

Lip-to-Lip run out

- Standard Cutter .002" / .05mm or greater
- Special Cutter .0005" / .013mm or less

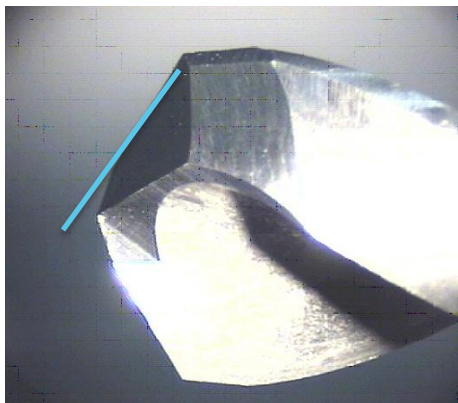
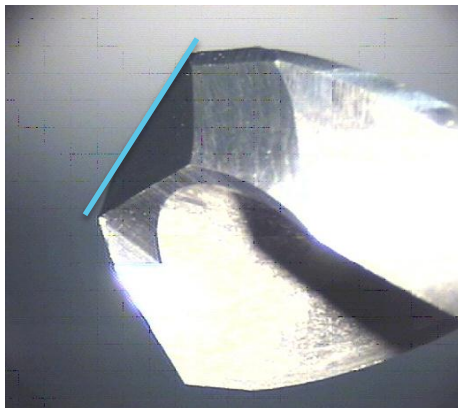

- Rotate tool 180°

- Excessive Lip Height variation or Lip-to-Lip run out is responsible for:
 - Producing a tapered hole
 - Over-sizing the hole
 - Premature tool wear
 - Corner of points being burned
 - Uneven wear on point
 - Reduced tool life
 - Breakage
 - Uneven chips

Materials

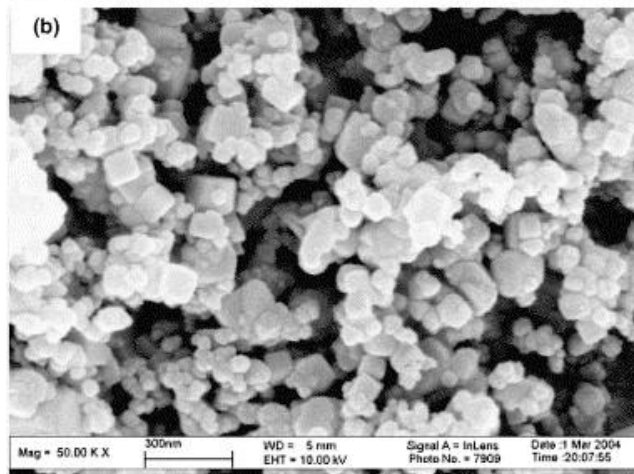
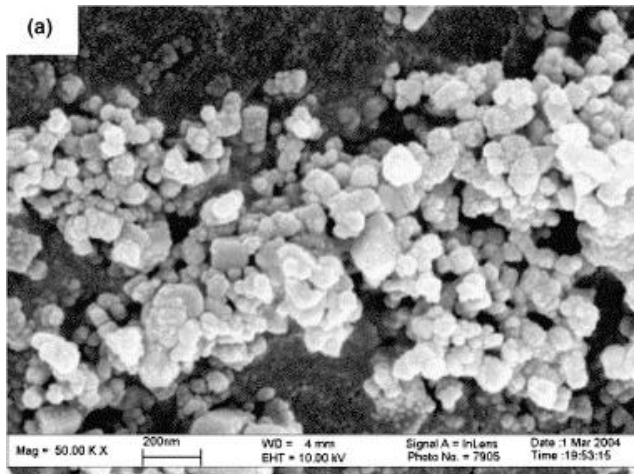

- HSS (High Speed Steel)
- Carbide
- PCD (Poly-crystalline diamond)

Coatings



- Coated cutters increased hole quality
 - Reduce torque
 - Increase micro edge geometry performance
 - Good wear resistance
 - Improve lubricity
 - Reduce heat at the cutting surface

Coatings

Multi layer diamond coating for composites sandwiches, aluminium and fibres (CFRP/Glare), **abrasive** resistance

a-C H coating, color grey black for dry applications (alu) and slight quantity lubrication, **abrasive** and **adhesive** wear resistance.

AlCrN, color bright-grey for **dry applications** (Alu-Inox-CF) and slight quantity lubrication, wear resistance and hot hardness properties.

TiAlN, for Alu-Ti-CF and other applications, minimal quantity lubrication, **good hot hardness and oxidation resistance**.



Regrinding

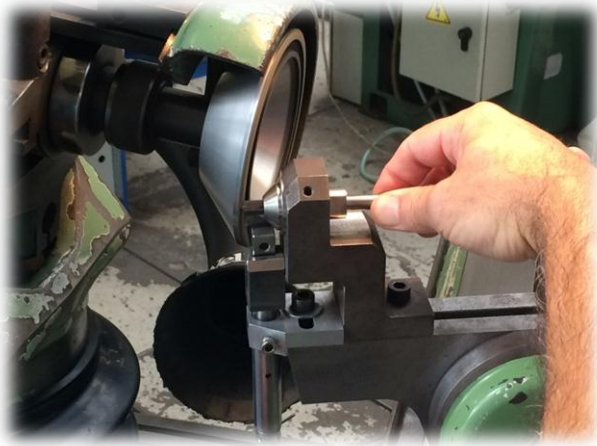

- Extends life of cutter
- Design for maximum number of regrinds
- Optimize the total number of holes from a cutter
- Regrind quality critical to maintain original design intent

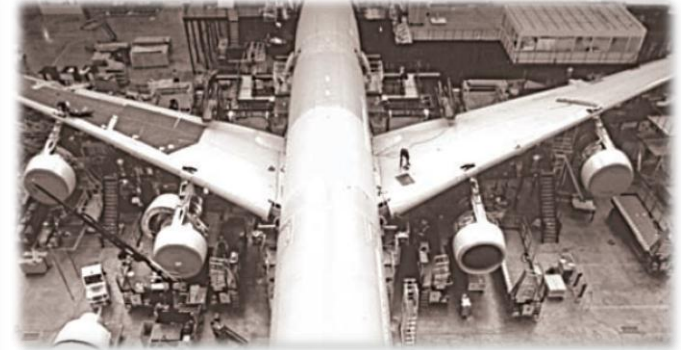
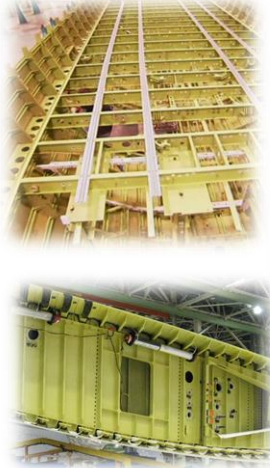

- Aerostructures
- Nose
- Fuselage
- Wings and Wingbox
- Shells
- Panels
- Tail
- Final Assembly



Precision

- Good surface finish
- Fit to application special cutter with tight tolerance

Productivity

- One shot applications cutters
- Cutters for high speed applications

Durability

- Special coatings to increase cutter lifetime
- Customized cutter design to reduce run-out

Total Cost of Ownership

- Increased holes per cutter
- Increase regrinds per cutter

Configurations & Options

Machining Operation

■ Drill only

- Split point is standard

■ Ream only

- Left hand helix
- Swarf directed away from cutter ensuring quality of surface finish and hole size

■ Drill and ream

- Produce good quality finished hole

■ Square drill

- Square drill is strong, permits good lubrication and chip formation
- Especially good for deep holes precision and good surface finish.
- Countersink is available

■ Drill and countersink

- Produces standard hole and countersink in one operation.
- Split point is standard

■ Ream and countersink

- Ream-Countersink cutter with pilot for accurate alignment in pre-drilled hole.

■ Taperlock ream and countersink HSS

- Taper-Lock specifications are based on Briles standards.
- However, many variations exist and complete specifications are required.
- Limited attachment interface options

Cutter Material

HSS Carbide PCD

HSS Carbide

HSS Carbide

HSS Carbide PCD

HSS Carbide PCD

HSS Carbide PCD

HSS

Illustration

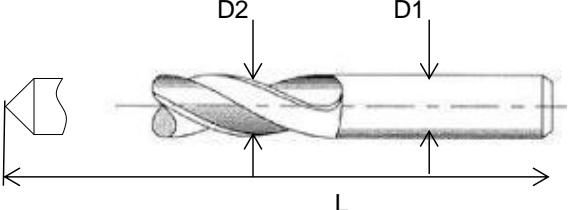
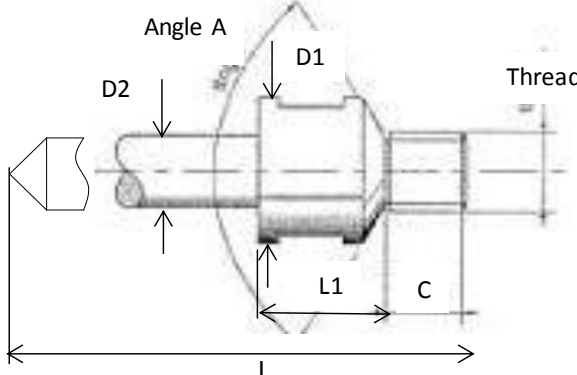
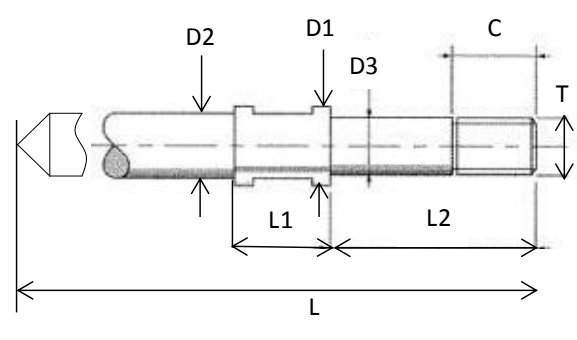

Cutter/spindle interface options

Picture Reference	Cutter Mounting Type	Code	Dimensions							
	Straight Shank	A	Shank Diameter		Cutter Diameter		Overall Length			
			D1	D2						
			in	mm	in	mm	in	mm		
			[Input Field]		[Input Field]		[Input Field]			
	External Thread with Seat Angle	B	Thread		Thread Length		Seat Angle			
			T	C			A			
			in	mm	in	mm	Degrees			
			[Input Field]		[Input Field]		[Input Field]			
			Body Diameter		Body Length		Cutter Diameter		Overall Length	
			D1	L1			D2	L		
			in	mm	in	mm	in	mm	in	mm
			[Input Field]		[Input Field]		[Input Field]		[Input Field]	
	External Thread with Pilot Diameter	C	Thread		Thread Length		Pilot Diameter		Pilot Length	
			T	C			D3		L2	
			in	mm	in	mm	in	mm	in	mm
			[Input Field]		[Input Field]		[Input Field]		[Input Field]	
			Body Diameter		Body Length		Cutter Diameter		Overall Length	
			D1	L1			D2	L		
			in	mm	in	mm	in	mm	in	mm
			[Input Field]		[Input Field]		[Input Field]		[Input Field]	

Cutter/spindle interface options

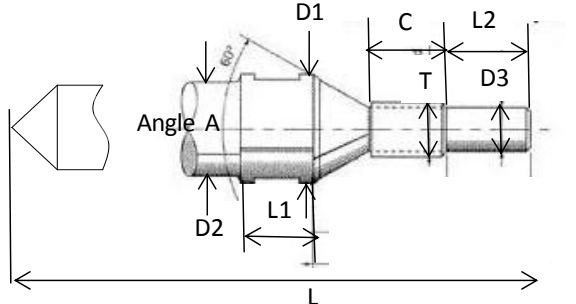
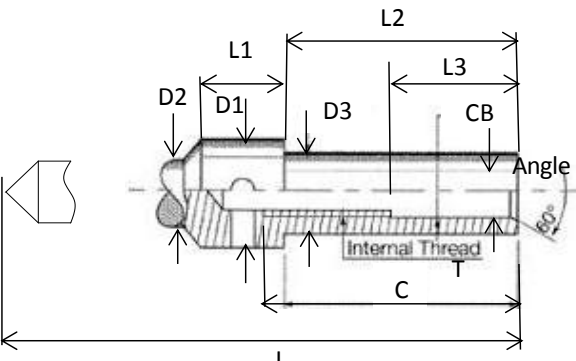
Picture Reference	Cutter Mounting Type	Code	Dimensions							
	External thread with Pilot Diameter and Seat Angle	D	Thread		Thread Length		Pilot Diameter		Pilot Length	
			T	C	D3	L2				
			in	mm	in	mm	in	mm	in	mm
			Seat Angle		A	Degrees				
			Body Diameter		Body Length		Cutter Diameter		Overall Length	
			D1	L1	D2	L				
			in	mm	in	mm	in	mm	in	mm
	Internal Thread Optional Counterbore Larger Body diameter	E	Internal Thread		Thread Length		Diameter		Length	
			T	C	D3	L2				
			in	mm	in	mm	in	mm	in	mm
			Counterbore Diameter CB		Length L3		Seat Angle A Degrees			
			in	mm	in	mm				
			Body Diameter		Body Length		Cutter Diameter		Overall Length	
			D1	L1	D2	L				
			in	mm	in	mm	in	mm	in	mm

Related ATG Products



Products

Advanced Drilling

- Positive Feed



- Self Colleting



Cutters

- Countersinking (Manual)



- Back Spot Face



Tightening

- DC Electric Fastening



- Pneumatic Fastening



- Riveting



- Bits & Sockets

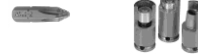

Material Removal

- Hand Drills & Microstop Cages



- Rivet Shavers



- Grinders



- Sanders



Universal Joints

- Universal Joints



Custom Solution/Service



Brands

